



20CTH03SPbF  
20CTH03-1PbF

## Hyperfast Rectifier

### Features

- Hyperfast Recovery Time
- Low Forward Voltage Drop
- Low Leakage Current
- 175°C Operating Junction Temperature
- Lead-Free ("PbF" suffix)

$t_{rr} = 35\text{ns max.}$   
 $I_{F(AV)} = 20\text{Amp}$   
 $V_R = 300\text{V}$

### Description/ Applications

International Rectifier's 300V series are the state of the art Hyperfast recovery rectifiers designed with optimized performance of forward voltage drop and Hyperfast recovery time.

The planar structure and the platinum doped life time control guarantee the best overall performance, ruggedness and reliability characteristics.



These devices are intended for use in the output rectification stage of SMPS, UPS, DC-DC converters as well as freewheeling diodes in low voltage inverters and chopper motor drives.

Their extremely optimized stored charge and low recovery current minimize the switching losses and reduce over dissipation in the switching element and snubbers.

### Absolute Maximum Ratings

Parameters		Max	Units
$V_{RRM}$	Peak Repetitive Reverse Voltage	300	V
$I_{F(AV)}$	Average Rectified Forward Current @ $T_C = 160^\circ\text{C}$ Per Diode	10	A
		20	
$I_{FSM}$	Non Repetitive Peak Surge Current @ $T_J = 25^\circ\text{C}$	120	
$T_J, T_{STG}$	Operating Junction and Storage Temperatures	- 65 to 175	$^\circ\text{C}$

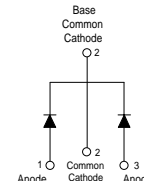
### Case Styles

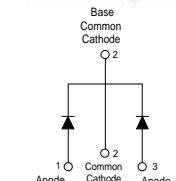
<p>20CTH03SPbF</p>  <p>Base Common Cathode</p> <p>2</p>  <p>1 Anode 2 Common Cathode 3 Anode</p> <p>D<sup>2</sup>PAK</p>	<p>20CTH03-1PbF</p>  <p>Base Common Cathode</p> <p>2</p>  <p>1 Anode 2 Common Cathode 3 Anode</p> <p>TO-262</p>
--	---

**Electrical Characteristics @ T<sub>J</sub> = 25°C (unless otherwise specified)**

Parameters	Min	Typ	Max	Units	Test Conditions
V <sub>BR</sub> , V <sub>F</sub> Breakdown Voltage, Blocking Voltage	300	-	-	V	I <sub>R</sub> = 100μA
V <sub>F</sub> Forward Voltage	-	1.05	1.25	V	I <sub>F</sub> = 10A, T <sub>J</sub> = 25°C
	-	0.85	0.95	V	I <sub>F</sub> = 10A, T <sub>J</sub> = 125°C
I <sub>R</sub> Reverse Leakage Current	-	-	20	μA	V <sub>R</sub> = V <sub>R</sub> Rated
	-	6	200	μA	T <sub>J</sub> = 125°C, V <sub>R</sub> = V <sub>R</sub> Rated
C <sub>T</sub> Junction Capacitance	-	30	-	pF	V <sub>R</sub> = 300V
L <sub>S</sub> Series Inductance	-	8	-	nH	Measured lead to lead 5mm from package body

**Dynamic Recovery Characteristics @ T<sub>C</sub> = 25°C (unless otherwise specified)**

Parameters	Min	Typ	Max	Units	Test Conditions
t <sub>rr</sub> Reverse Recovery Time	-	-	35	ns	I <sub>F</sub> = 1A, di <sub>F</sub> /dt = 50A/μs, V <sub>R</sub> = 30V
	-	-	30		I <sub>F</sub> = 1A, di <sub>F</sub> /dt = 100A/μs, V <sub>R</sub> = 30V
	-	31	-		T <sub>J</sub> = 25°C
	-	42	-		T <sub>J</sub> = 125°C
I <sub>RRM</sub> Peak Recovery Current	-	2.4	-	A	T <sub>J</sub> = 25°C
	-	5.6	-		T <sub>J</sub> = 125°C
Q <sub>rr</sub> Reverse Recovery Charge	-	36	-	nC	T <sub>J</sub> = 25°C
	-	120	-		T <sub>J</sub> = 125°C

I<sub>F</sub> = 10A  
di<sub>F</sub>/dt = 200A/μs  
V<sub>R</sub> = 200V

**Thermal - Mechanical Characteristics**

Parameters	Min	Typ	Max	Units
T <sub>J</sub> Max. Junction Temperature Range	- 65	-	175	°C
T <sub>Stg</sub> Max. Storage Temperature Range	- 65	-	175	
R <sub>thJC</sub> Thermal Resistance, Junction to Case	-	-	1.5	°C/W
Weight	-	2.0	-	g
	-	0.07	-	(oz)
Mounting Torque	6.0	-	12	Kg-cm
	5.0	-	10	lbf.in
Marking Device	20CTH03S		Case style D <sup>2</sup> Pak	
	20CTH03-1		Case style TO-262	

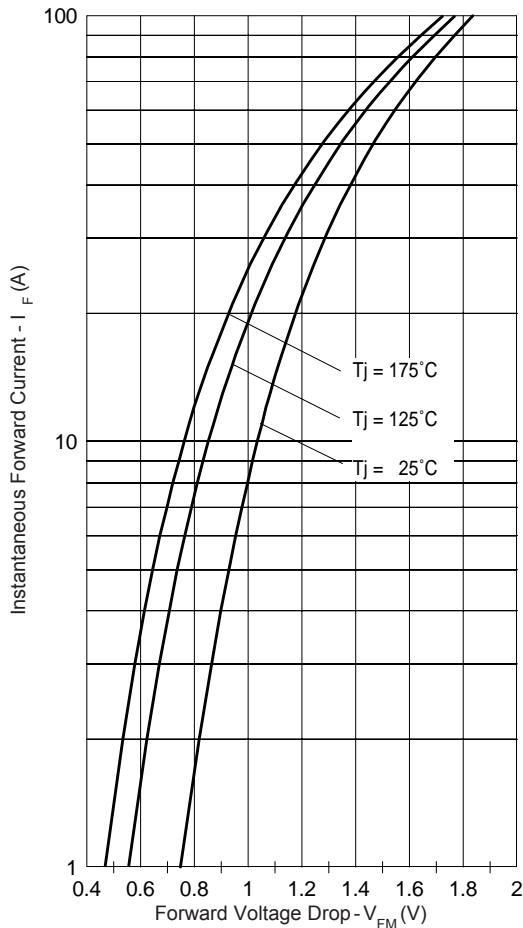

Fig. 1 - Typical Forward Voltage Drop Characteristics

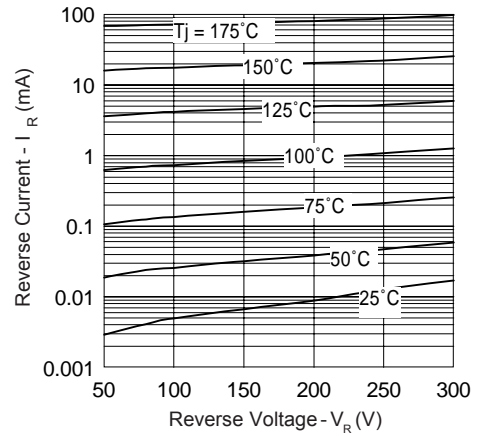

Fig. 2 - Typical Values of Reverse Current Vs. Reverse Voltage

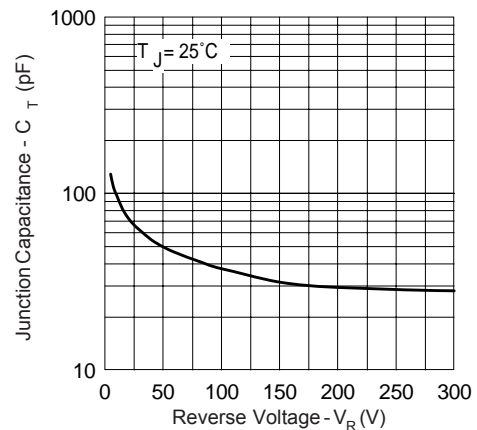

Fig. 3 - Typical Junction Capacitance Vs. Reverse Voltage

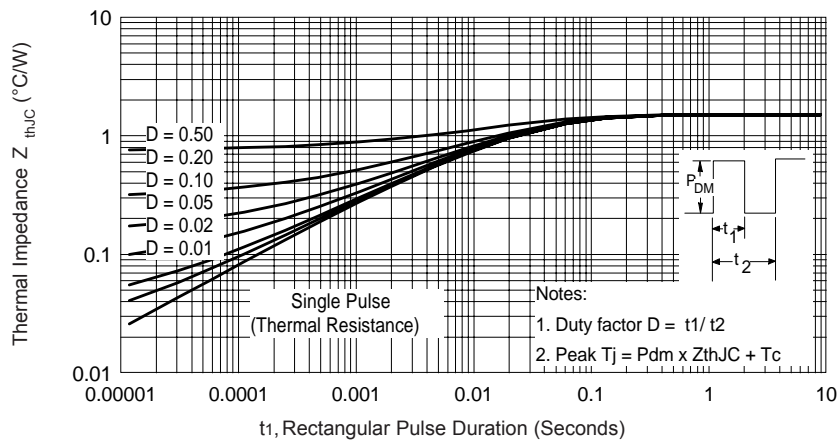
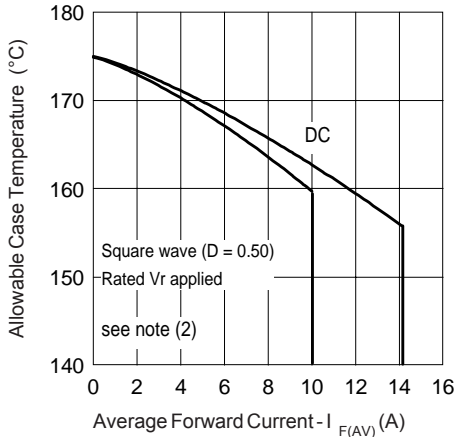
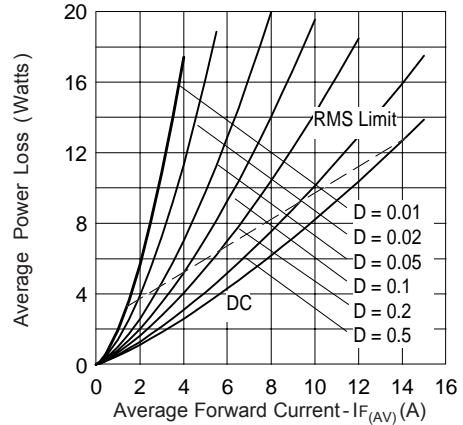

Fig. 4 - Max. Thermal Impedance  $Z_{thJC}$  Characteristics



**Fig. 5 - Max. Allowable Case Temperature Vs. Average Forward Current**



**Fig. 6 - Forward Power Loss Characteristics**

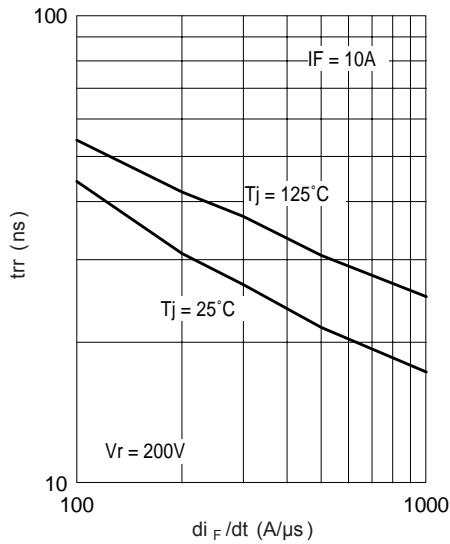

**Fig. 7 - Typical Reverse Recovery vs. di\_F/dt**

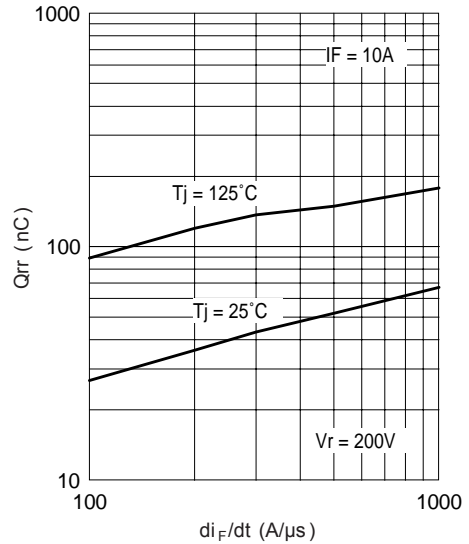

**Fig. 8 - Typical Stored Charge vs. di\_F/dt**

(2) Formula used:  $T_C = T_J - (Pd + Pd_{REV}) \times R_{thJC}$ ;  $Pd = \text{Forward Power Loss} = I_{F(AV)} \times V_{FM} @ (I_{F(AV)}/D)$  (see Fig. 8);  
 $Pd_{REV} = \text{Inverse Power Loss} = V_{R1} \times I_{R1} (1 - D)$ ;  $I_{R1} @ V_{R1} = \text{rated } V_R$

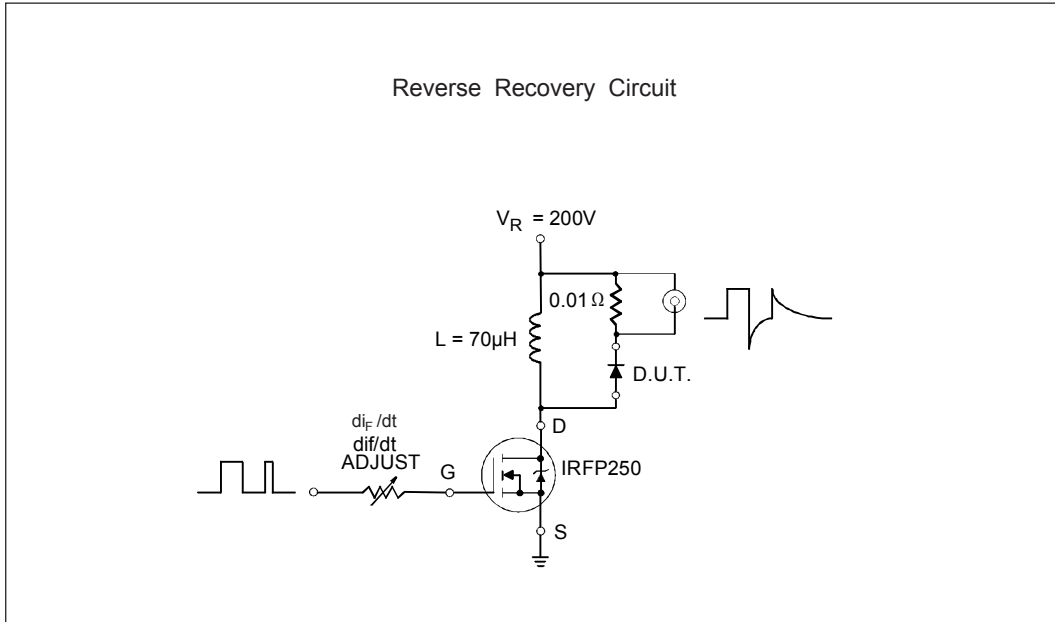

Fig. 9- Reverse Recovery Parameter Test Circuit

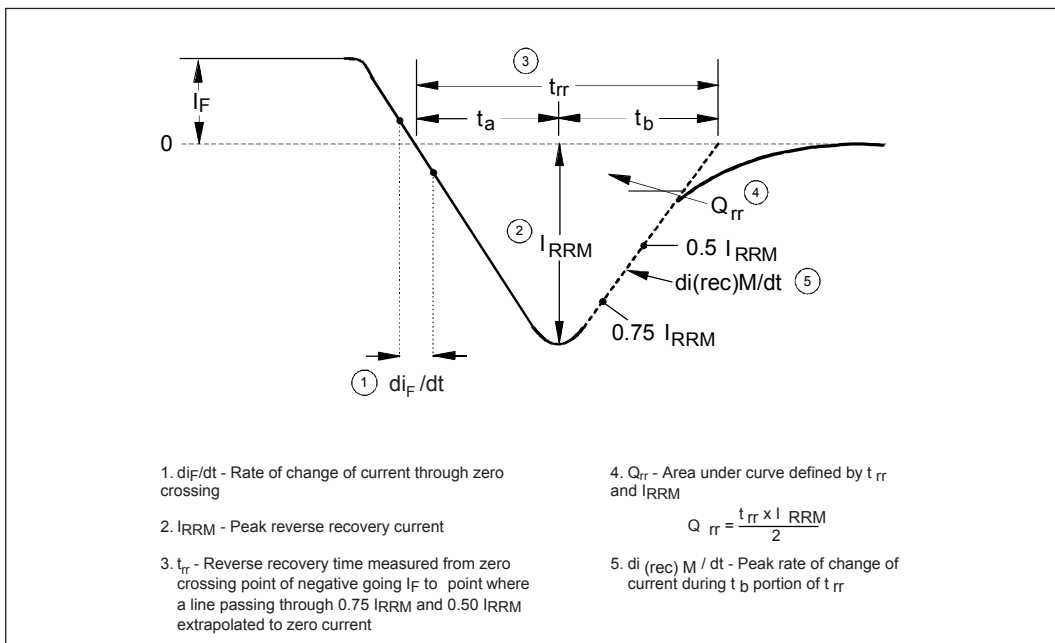
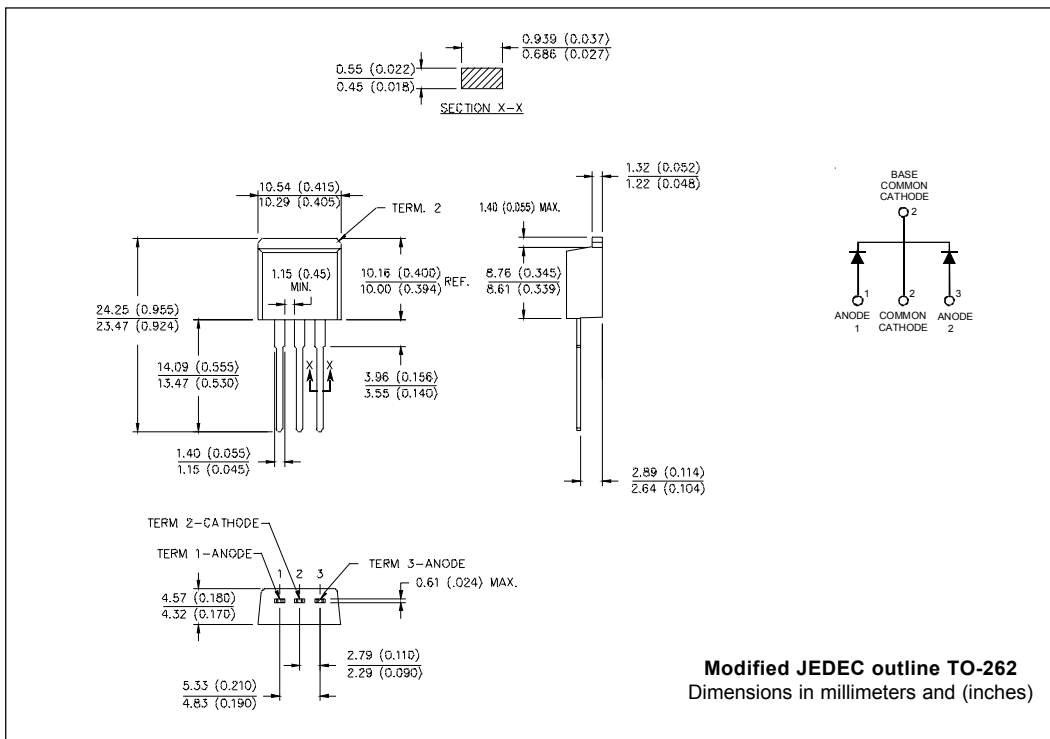
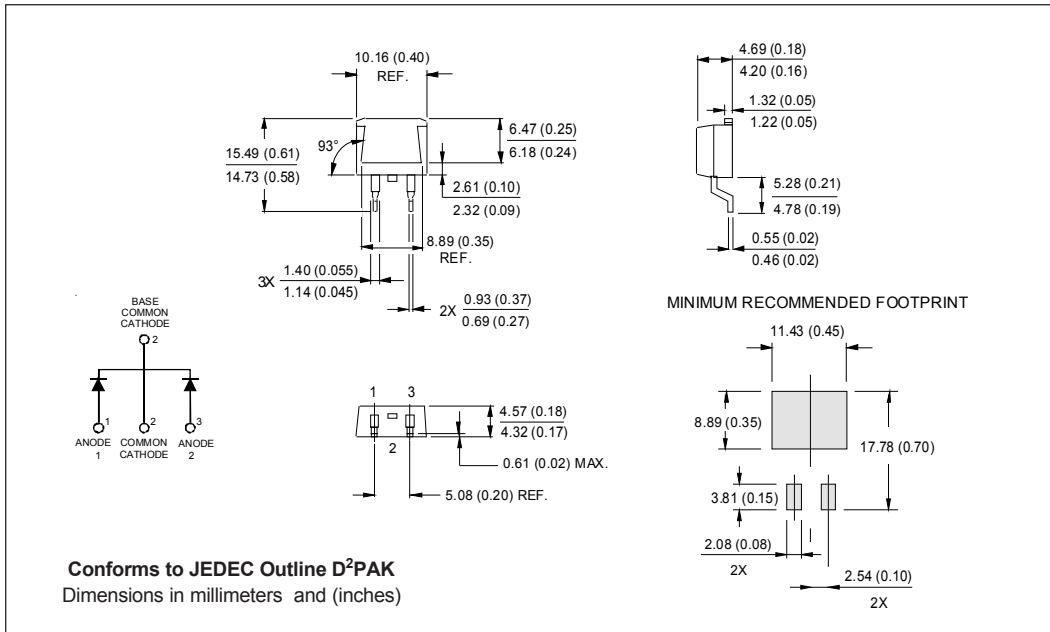

Fig. 11 - Reverse Recovery Waveform and Definitions

Outline Table



Part Marking Information

**D<sup>2</sup>PAK**

EXAMPLE: THIS IS A 20CTH03S  
 LOT CODE 8024  
 ASSEMBLED ON WW 02, 2000

Note: "P" in assembly line position indicates "Lead-Free"

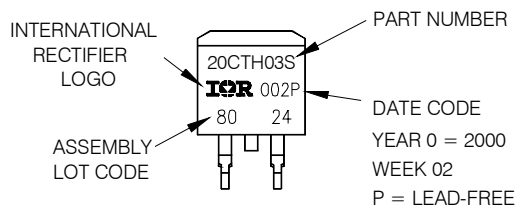

**TO-262**

EXAMPLE: THIS IS A 20CTH03-1  
 LOT CODE 8024  
 ASSEMBLED ON WW 02, 2000

Note: "P" in assembly line position indicates "Lead-Free"

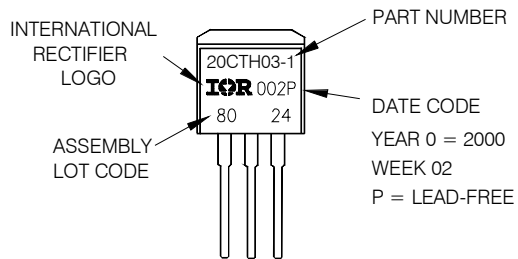

Tape & Reel Information

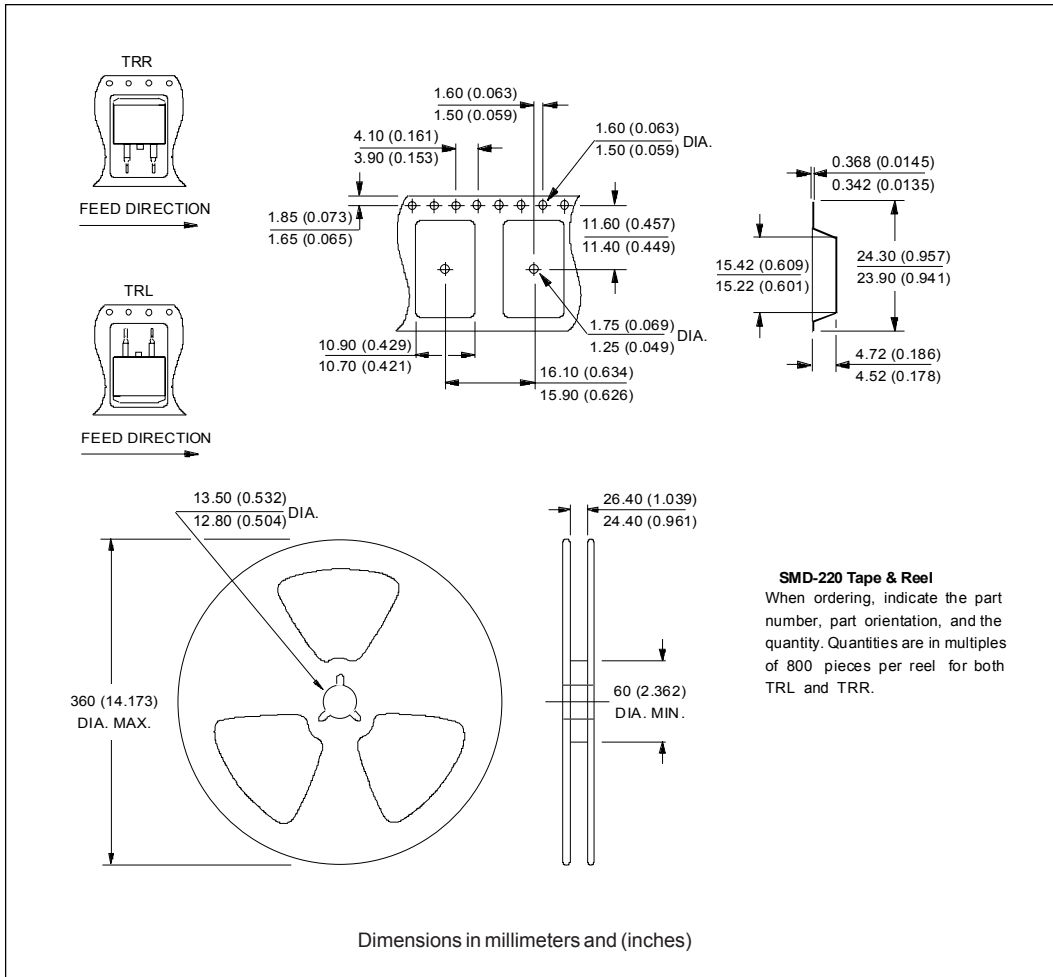

**SMD-220 Tape & Reel**  
When ordering, indicate the part number, part orientation, and the quantity. Quantities are in multiples of 800 pieces per reel for both TRL and TRR.



Ordering Information Table

Device Code																	
	<table border="1" style="margin: auto;"> <tr> <td style="padding: 5px;">20</td> <td style="padding: 5px;">C</td> <td style="padding: 5px;">T</td> <td style="padding: 5px;">H</td> <td style="padding: 5px;">03</td> <td style="padding: 5px;">S</td> <td style="padding: 5px;">TRL</td> <td style="padding: 5px;">PbF</td> </tr> <tr> <td style="text-align: center;">①</td> <td style="text-align: center;">②</td> <td style="text-align: center;">③</td> <td style="text-align: center;">④</td> <td style="text-align: center;">⑤</td> <td style="text-align: center;">⑥</td> <td style="text-align: center;">⑦</td> <td style="text-align: center;">⑧</td> </tr> </table>	20	C	T	H	03	S	TRL	PbF	①	②	③	④	⑤	⑥	⑦	⑧
20	C	T	H	03	S	TRL	PbF										
①	②	③	④	⑤	⑥	⑦	⑧										
<b>1</b>	- Current Rating (20A)																
<b>2</b>	- C = Common Cathode																
<b>3</b>	- T = TO-220, D <sup>2</sup> Pak																
<b>4</b>	- H = Hyperfast Rectifier																
<b>5</b>	- Voltage Rating (03 = 300V)																
<b>6</b>	- <ul style="list-style-type: none"> <li>• S = D<sup>2</sup>Pak</li> <li>• -1 = TO-262</li> </ul>																
<b>7</b>	- <ul style="list-style-type: none"> <li>• none = Tube (50 pieces)</li> <li>• TRL = Tape &amp; Reel (Left Oriented, for D<sup>2</sup>PAK package)</li> <li>• TRR = Tape &amp; Reel (Right Oriented, for D<sup>2</sup>PAK package)</li> </ul>																
<b>8</b>	- <ul style="list-style-type: none"> <li>• none = Standard Production</li> <li>• PbF = Lead-Free</li> </ul>																

Data and specifications subject to change without notice.  
 This product has been designed and qualified for Industrial Level and Lead-Free.  
 Qualification Standards can be found on IR's Web site.